

6K1052

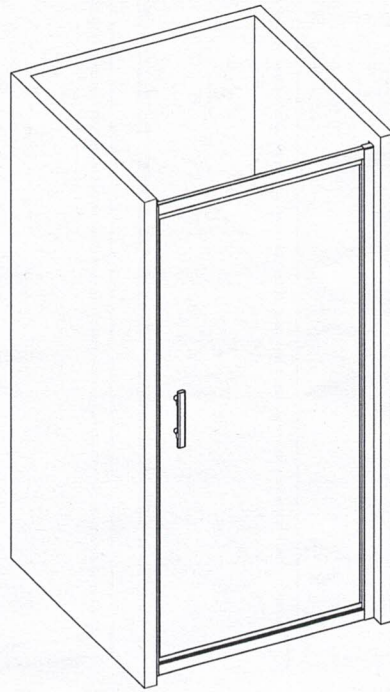

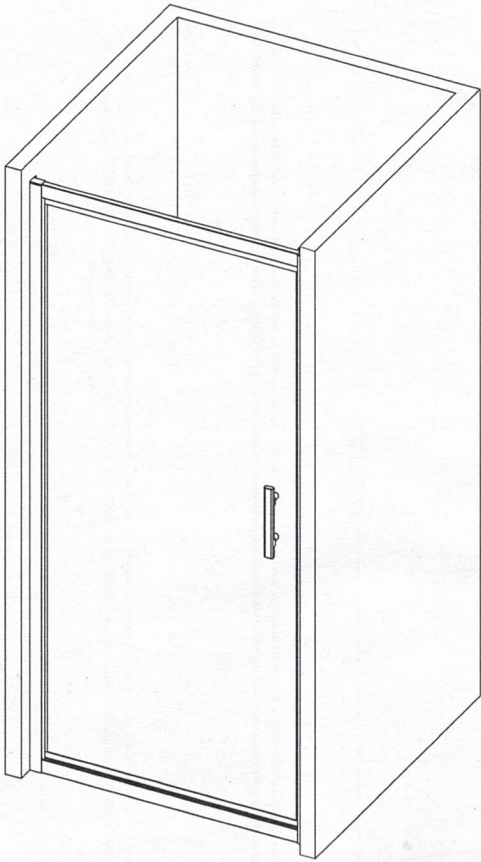

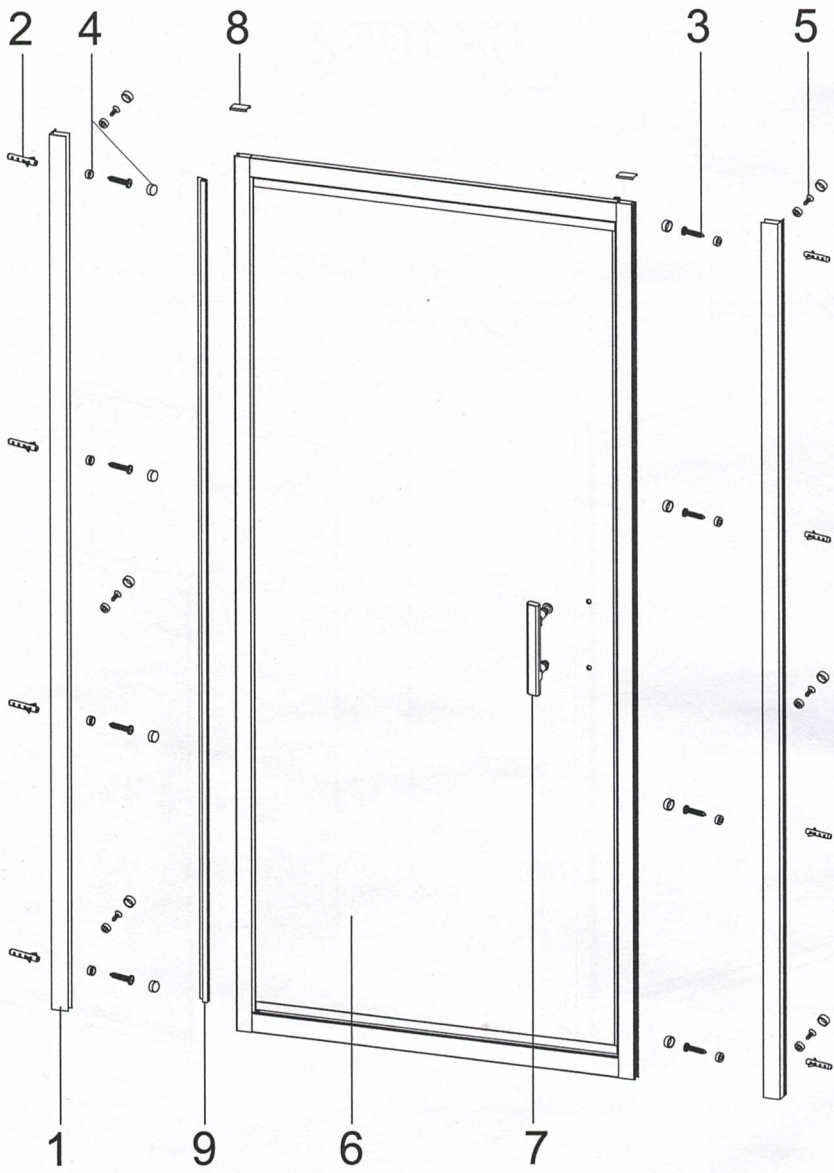

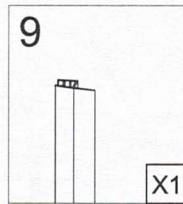
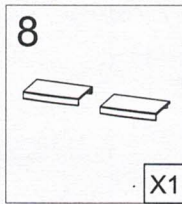
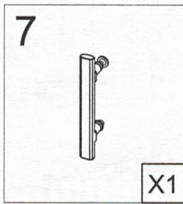
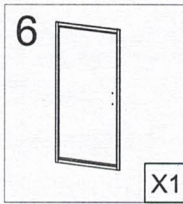
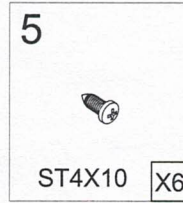
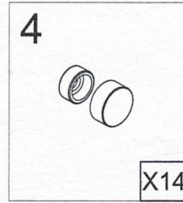
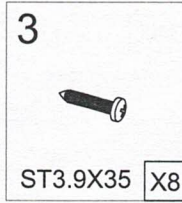
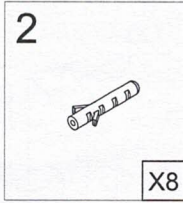
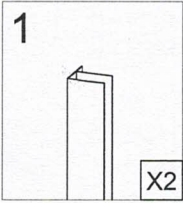
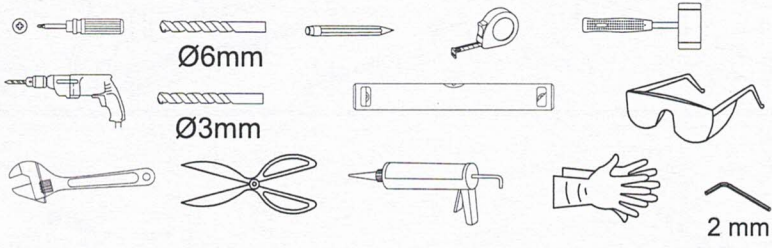
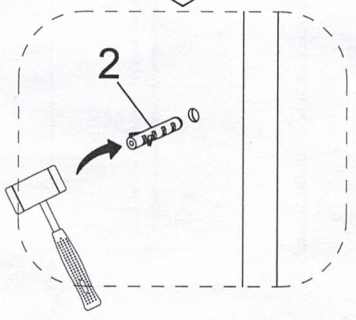
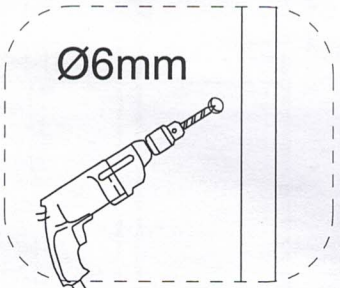
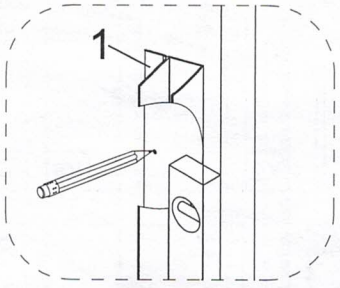
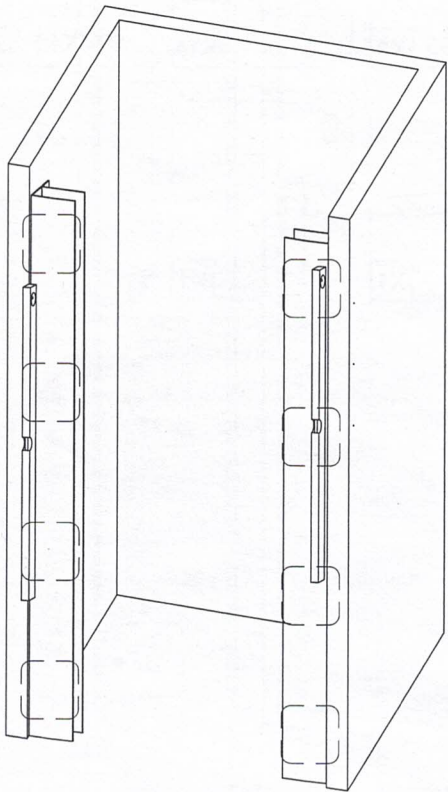
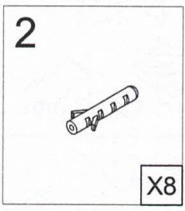

3



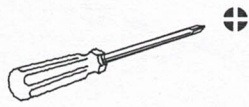
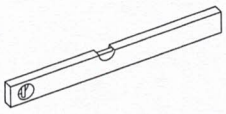

1



X1

3



ST3.9X35 X4

4



X4

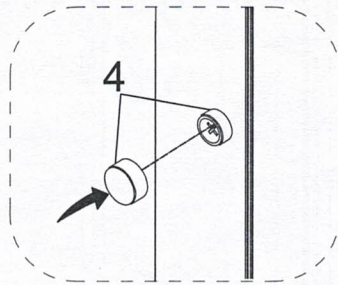
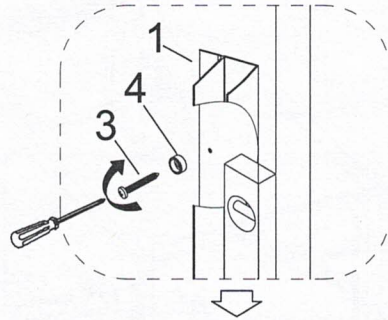
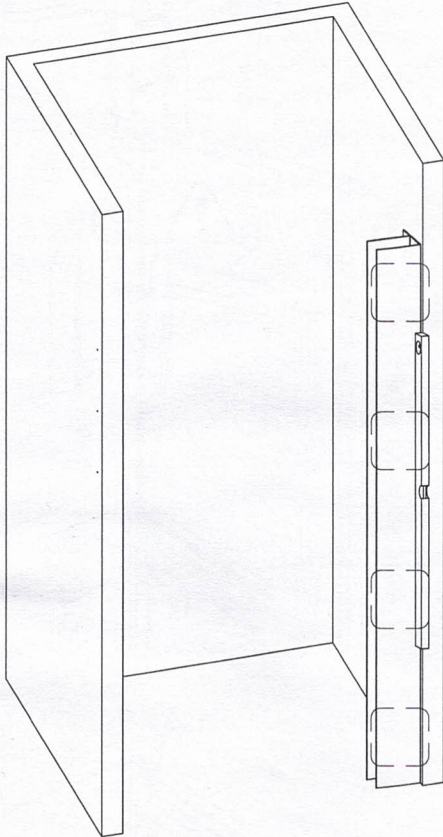

4

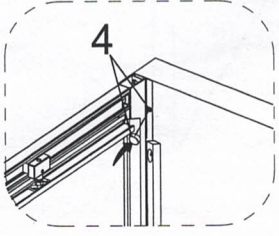
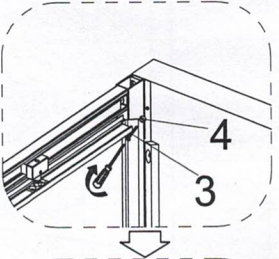
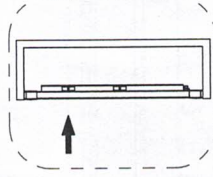
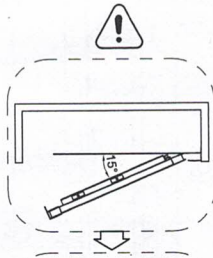
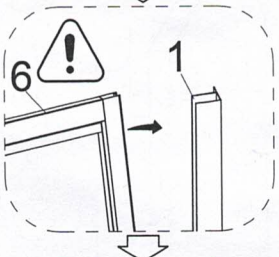
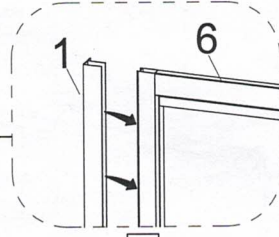
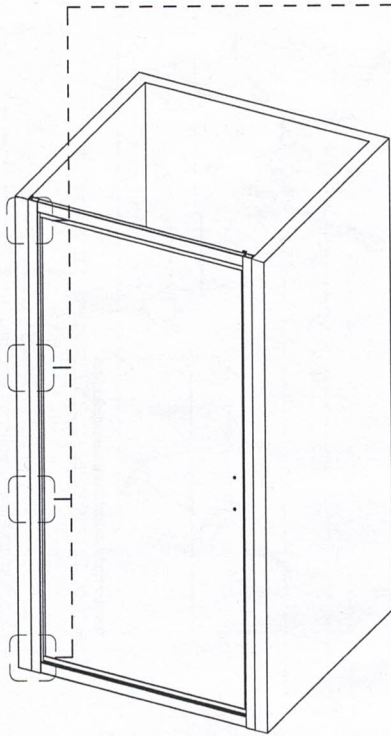
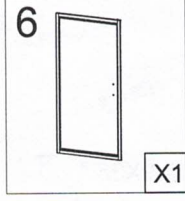
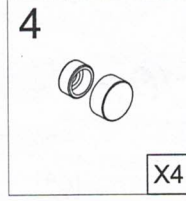
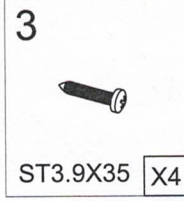
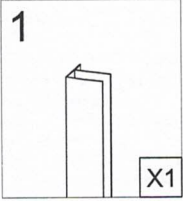
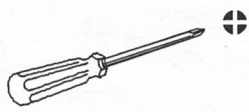
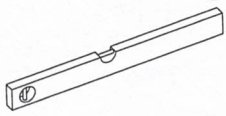

5

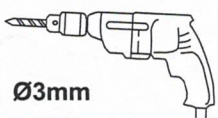
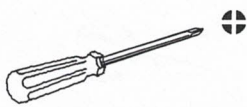
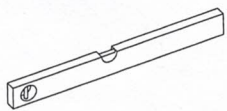

Ø3mm

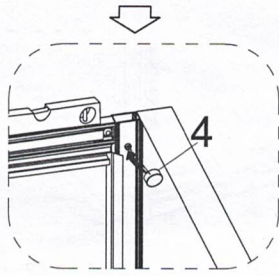
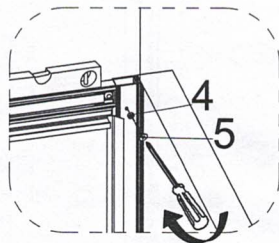
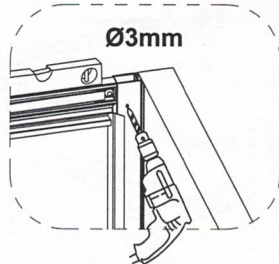
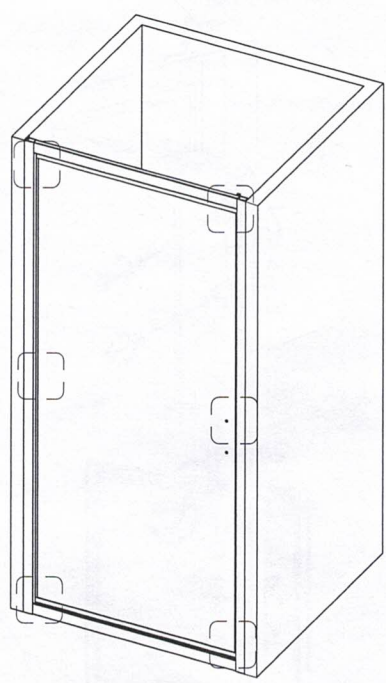
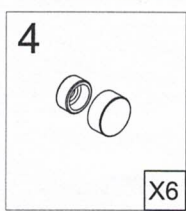

6



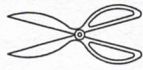

2 mm

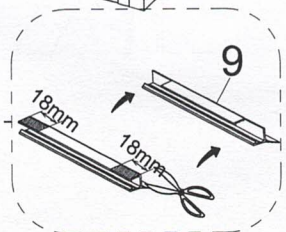
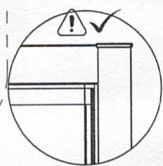
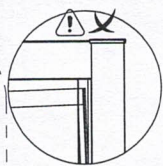
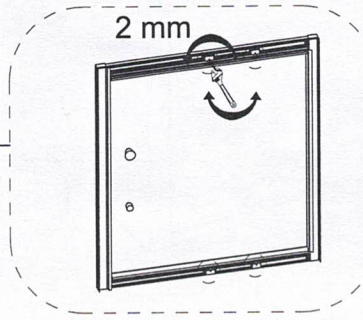
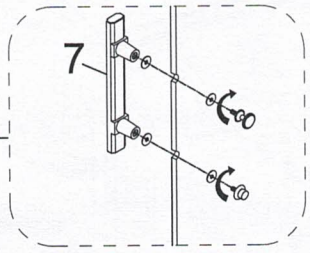
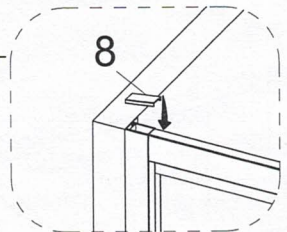
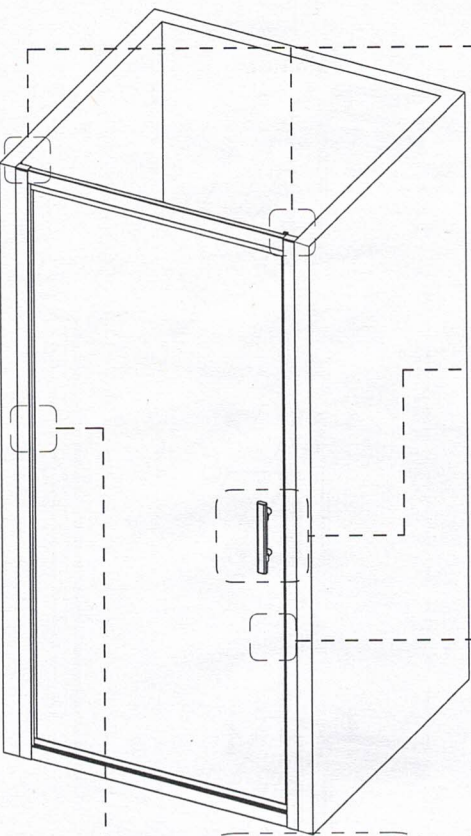
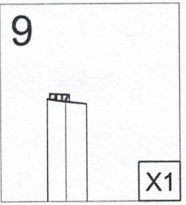
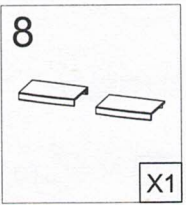
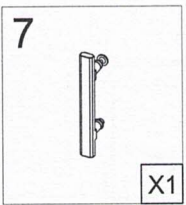

7

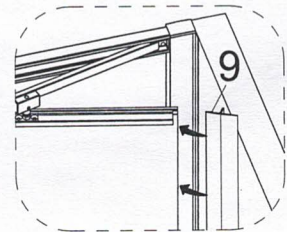



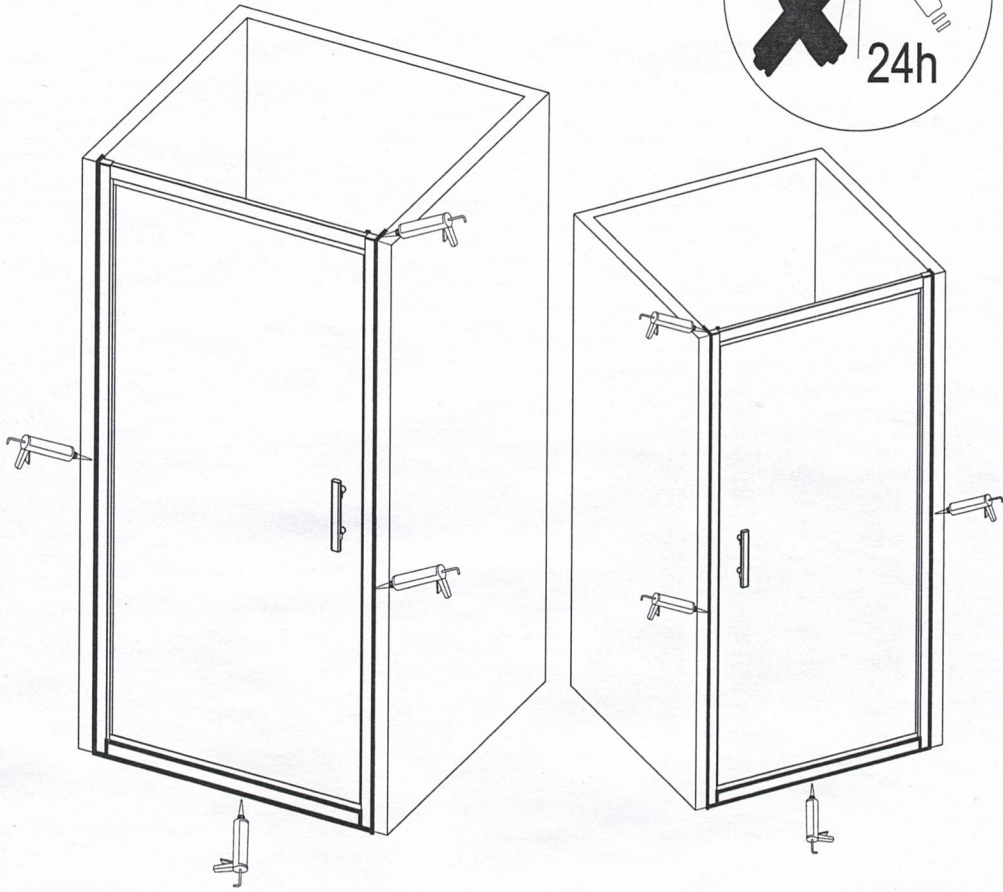
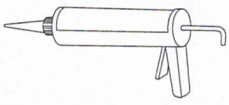

8