

# Smart Toilet Seat Manual

## Model

Thanks for choosing our product

And please read the instructions carefully before using.

The pictures are for reference only, please refer to the actual product



# Contents

---

## Before use

---

Safety precautions .....	1
Overall sketch .....	6
Function introduction .....	7

## Installation guide

---

Precautions before installation .....	8
Toilet Seat installation .....	9

## Operation

---

Operation introduction .....	11
Preparation .....	11
Product use .....	12
Troubleshooting .....	16
Cleaning and Maintenance .....	17

## Appendix



---

Product specification .....	19
Packing list .....	20



# Safety precautions



Please read the “safety precautions” carefully before use, all the precautions listed here are connected to safety. It's important and must be followed.

## Sign and meaning

	<b>Warning</b>	Represents improper operations by ignoring the instructions may result in death or injury
	<b>Notice</b>	Represents improper operations by ignoring the instructions may result in body injury and property loss

The following signs are used for important safety precautions.

Sign	meaning
	It represents not allowed, “forbid”
	It represents enforced to do

 <b>WARNING</b>	
	<p>Please do not touch the electrical outlet with wet hand</p> <ul style="list-style-type: none"> <li>• Or it may cause electric shock</li> </ul> <p>Please do not pour water, hot water or detergent on the top of the toilet and electrical outlet</p> <ul style="list-style-type: none"> <li>• Or it may cause fire, electric shock, heat or short circuit</li> <li>• Or it may cause injury and indoor water seepage because of the damage of product</li> </ul> <p>Never attempt to disassemble, repair, or alter the product yourself.</p> <ul style="list-style-type: none"> <li>• Or it may cause fire, electric shock, heat or short circuit</li> </ul> <p>Please do not install the toilet in car, ship or any other moving object.</p> <ul style="list-style-type: none"> <li>• Or it may cause fire, electric shock, short circuit or fault.</li> <li>• Or the ceramic, seat and main part will be damaged because of falling down.</li> </ul> <p>Stop using while it breakdown</p> <p>Under the following condition, please disconnect the power supply and turn off the water angle valve</p> <ul style="list-style-type: none"> <li>— Water leakage from pipe or inside of the product</li> <li>— crack or damage on the product</li> <li>— unusual sound or smell</li> <li>— Smoke</li> <li>— Unusual heating</li> <li>— Block</li> <li>— Fall out of the cushion</li> </ul> <ul style="list-style-type: none"> <li>• Continue using the toilet by ignoring the faults may result in fire, electric shock, heat, short circuit, injury and indoor water seepage</li> </ul>



## WARNING



Please don't use seawater and other water except tap water or drinkable well water(underground water)

- Or it may cause skin inflammation or fault

Please do not touch the electrical plug while thunder

- Or it may cause electric shock

Please do not let the water inlet soft pipe connect to the electrical plug and outlet

- Or it may cause fire, electric shock, heat, short circuit because of moisture condensation

Please do not destroy power cable or plug

Does not strike, yank, twist, excessively bend, damage, or alter the electrical cords. Also, do not place anything heavy on, bind or pinch the cords.

- Or it may cause fire, electric shock, heat and short circuit if it's broken

Please do not use a loose or faulty electrical outlet.

- Or it may cause fire or short circuit.

Please use the electrical outlet and wire appliance in specified area.

- Or it may cause fire because of wire appliance is not in the rule of outlet.

Please do not put finger or anything else into the warm air outlet.

Please do not put objects or clothes on the air outlet or cover it.

- Or it may cause scald, electric shock or accessories burn down.

Please keep cigarettes and other open flames away from the product

- Or it may cause fire.



Pay attention to the low temp scalding

- Improper use of warm seat may cause low temp scalding.

If you sit for long time, please turn the temp setting to "off" level.

Please turn the seat temp setting to "off" level, warm air dry temp to "low" level under following situations.

- Children and elders those who can not adjust the temp to the proper level
- Patient and disabled people those who have problem in behavior.
- People who have take medicine with hypnosis effect(hypnotics, cold cure and etc), or are excessive drinking, too tired and somnolence.

This is an electrical product, please do not install it in a place where is easily get wet or with high humidity. If installed in bathroom, please also install ventilator to maintain the bathroom ventilation.

- Or it may cause fire or electric shock.

The product must be connected to cold water supply.

- Or it may cause body burn or machine fault.

The product must be connected to the ground correctly.

- If not connected to the ground, it may cause electric shock.

The ground processing here requires the ground resistance under 100Ω, the earth wire of switchboard is over Ø1.5mm, with copper material. (please entrust installation company to do the job)



## WARNING

Please confirm if the electrical outlet is connected to the ground

- Or it may cause electric shock because of fault or short circuit.

The outlet for power wire should obey the following rules.

- Or it may cause fire or electric shock.
  - a. Please use high sensibility and fast response leakage switch (rated induced currents below 15mA) or insulating transformer (1.5kVA~3kVA) to protect outlet loop.
  - b. Please reserved the installation place for outlet and keep it away from bathtub.
- \* Please confirm above a , b wiring projects are finished. Or please entrust the engineering contractor to do this job.

The electrical plug should be inserted to the outlet firmly.

- Or it may cause fire, heat or short circuit.

Please hold the plug not the wire when pulling out the plug.

Please do not grasp the wire to pull out the plug.

- Or it may cause fire or heat because of broken wire.

If the power soft wire is broken, to avoid danger, please ask the maintenance department of company or similar departments to replace it.

Please be sure to turn off the power while doing the maintenance or spot check.

- Or it may cause electric shock or accessories burn down.
- \* Not include “ nozzle clean”

Disabled people or who is lack of experience or common sense ( including children) should be accompanied with personnel guardian while using this product.

- Or it may cause scald, electric shock, fire and body injury.

Please do not let children play this product.

- Or it may cause scald, electric shock, fire and body injury.

Do not throw lighted cigarettes and other flaming material into the toilet.

- Or it may cause fire.

Strong magnets inside, the body is equipped with a pacemaker and other auxiliary medical equipment, please do not use.





## NOTICE

Please do not use the product when it's loose.

- Or the toilet and seat may separate and fall off to cause body injury

Please do not touch broken area.

- Or it may cause injury, please replace it as soon as possible.

Please do not impact forcefully, put heavy subject or stand on the product

- Or it may cause product damage, fall down or body injury
- Or it may cause body injury or indoor water seepage

Please do not pull the product by holding the seat or cover.

Please do not open the seat and cover when something on the product.

- Or the main body may fall off to cause body injury.

Please use kitchen detergent(neutral) to maintain the plastic part(seat cover, etc) and water inlet soft hose, please do not use the following materials [ bathroom detergent, house detergent, gasoline, banana oil, cleaning powder and nylon brush and so on]

- Or it may damage the plastic parts, cause cracks to body injury for fault
- Or it may cause water leakage because of damaged soft hose

To avoid sudden water leakage, please do not remove the water inlet filter when angle valve is open

[please refer to cleaning instruction of water inlet filter]

- Or the water may spray out

Please do not crush or bend water inlet hose

- Or it may cause water leakage

Please use the new hose that put inside the accessory box, the old one isn't recycled.

- Or it may cause water leakage

Please do not pour hot water into toilet

- Or it may cause body injury or indoor water seepage because of toilet damage

Please do not flush with big amount of toilet paper or other subjects except sewage and small amount toilet paper.

- Or it may cause body injury or indoor water seepage because of toilet damage

Please do not lean on the toilet cover while using

- Or it may destroy the seat cover.





## NOTICE

Please close the angle valve when water leaking

When room temp is under 0°C, to avoid piping or soft hose damaging because of frozen, anti freezing measures should be adopted.

- It may destroy main body or piping, leading to water leakage if water inlet soft hose is frozen.
- To avoid damage, please pay attention to room temp adjustment.

When not use for a long time, please must drain the inlet soft hose, and cut the power.

- When using next time, please open the angle valve and let water connected first. or it may cause skin inflammation because of bad water quality.
- It may cause fire or heat if the power supply is always connected.

Please must confirm if the filter has screwed to right position when install it.

- It may cause water leakage if not screwed tight.

When the toilet drain outlet is blocked, cut off the power then clean the obstruction

- Or the sewage may overflow, cause indoor water seepage because of auto flush function.
- Use the professional tools sold in the market to clean the obstruction.

Flush the toilet after pee

- Or it may cause difficulty in clean the toilet, block the drain outlet or sewage overflow, result in indoor water seepage.

Use the dried towel to clean the pee, dee, detergent, water and etc on the floor.

- Or it may leave dirt on the floor or corrode the floor.



# Overall Sketch

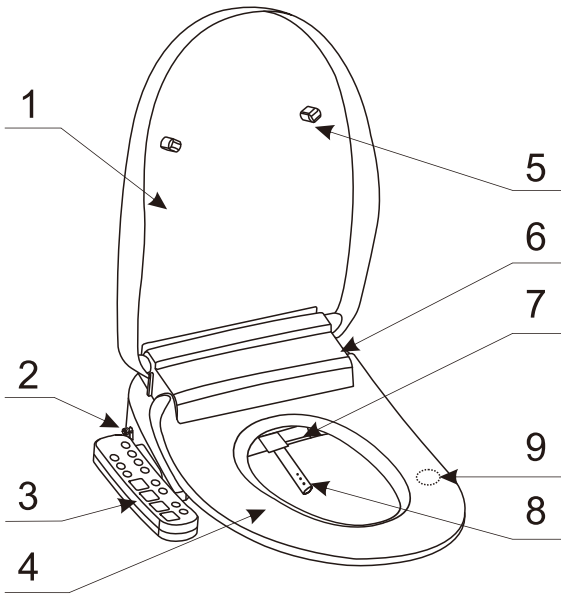

1	Toilet lid
2	Water inlet
3	Control panel
4	Heated seat
5	Cushion pad
6	Damper
7	Dryer outlet
8	Nozzle
9	Sensing area

## Install components

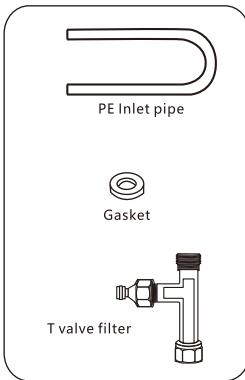

Waterway connection accessories

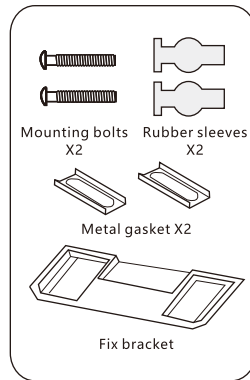

Seat fixing accessories

## NOTICE

The contents described in this manual include but are not limited to product material, process, functional characteristics, etc., which may be different from the actual product due to process improvement or product upgrade. Please refer to the actual product.



# Functions introductions

Function	Introduction
Rear wash	Provide rear cleansing
Rear oscillating Wash	Move the nozzle back and forth for rear cleansing
Front wash	Provide cleansing by front cleansing nozzle with a gentle spray
Front oscillating Wash	Move the nozzle back and forth with a gentle spray
Child wash	Children's special warm water gentle cleaning
One solution	Auto clean, flush and dry
Strong wash	Large amount of water to clean the buttocks to promote laxative
Lady care	Special cleaning of female's physiological period
Nozzle position adjustment	Adjust the suitable washing positions
Temperature adjustment	Set the temperature of seat and water
Water pressure adjustment	Change cleaning water pressure
Seat sensor	Functions activated by sitting on the seat
Drying	Dry the users after cleansing
Changing drying intensity	Control the temperature of warm air from the dryer
Nozzle self-clean	Provide nozzle self-cleaning before washing
Deodorizer	Removing odors
Saving energy	Saves electricity
Night light	Preparations for insufficient light
soft close	Damper in the seat and cover, to make it close softly
Power switch	Turn power on and off
UV sterilization *	Automatically activate after the human body left the seat

# Installation guide

## ※ Precautions before installation

- 1、 Before installation, toilet wall, floor tile, ceramic toilet has been completed, bathroom should supply water and power socket near by toilet.
- 2、 Water pressure should be between 0.06Mpa(flow)-0.75MPa (Static),water temperature 5℃-35℃.
- 3、 In case of the remain water within frozen,please put the product in a warm place wait to thaw then install it.
- 4、 Connect daily-use water pipe only.  
Do not connect to recycled water or industrial water supplies.  
Due to possible contamination as this would cause jamming or internal damage.
- 5、 Please be sure to use incidental T valve and filter.
- 6、 Don't put the power plug into the socket before finishing installation.

## ※ Install T valve filter

- 1、 Lock inlet valve to remove water pipe. See Picture 1.
- 2、 Connect T valve, filter and inlet valve. See picture 2.
- 3、 Install flush tank and inlet pipe. See picture 3.

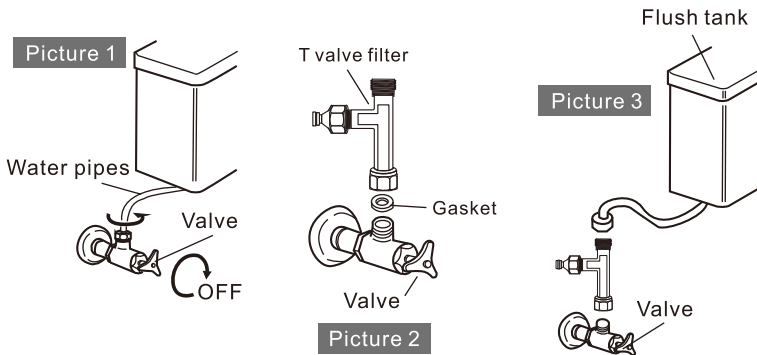

## ◆ Toilet Seat installation ◆

### ※ Remove original toilet seat

1. Wrench loosen bolt

2. Remove the nut and gasket, remove the toilet seat

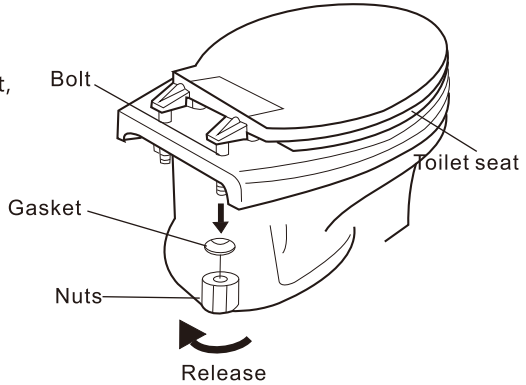

### ※ Install fix bracket

1. Before the installation, please put the product on the toilet bowl to check the fitness.

2. Embed and install the rubber sleeve, fix bracket, metal bracket in the picture shown, insert the mounting bolt and tighten it so that the fix bracket cannot move.

3. If the product does not match the toilet bowl ideally, please loosen the mounting bolts, take the metal gasket out, readjust the position of the fix bracket, then insert the metal gasket and tighten the bolt.

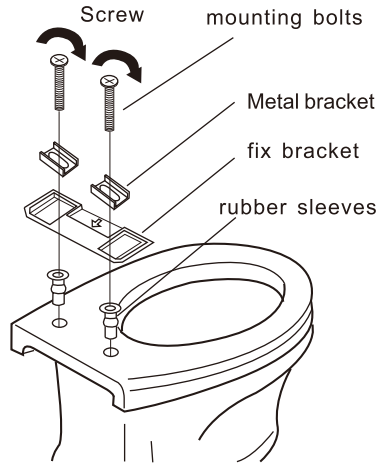

※ The fix bracket can adjust the range within 120-180mm

## ※ Install bidet

Aim the bottom card slot of the seat to the edge of fixed bracket, slide in gently, as you hear 'ka' sound means well installed

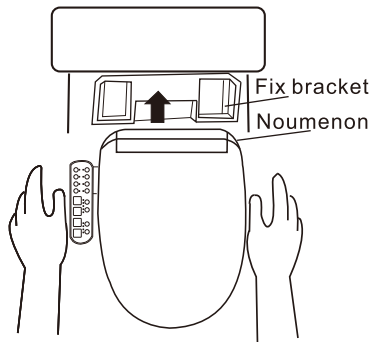

※ Notice: please don't forget the power cable between the toilet and bidet.

Be sure the bidet fixed as complete then lift bidet to fit it on correct position.

## ※ Connect inlet pipe

### Connect T valve

Hold on PE Inter to push it towards connector of T valve.

### Connect bidet

Hold on PE inter to push it towards connector of bidet.

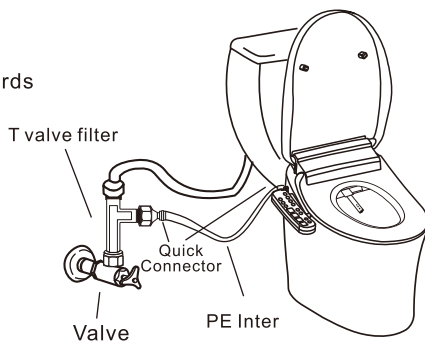

※ It is recommended to replace the PE pipe every year

※ Turn on inlet valve after connected, please check the connector part leakage or not.

# Operation

## ◆ Operation introduction

※ The following illustrations are for functional descriptions only, the full light state is not the actual state.

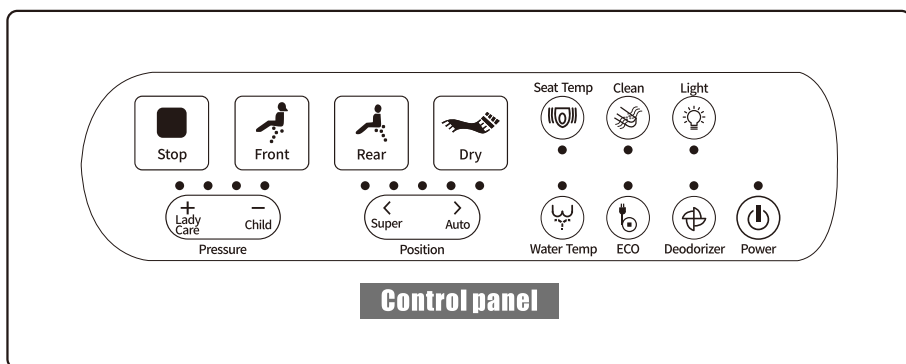

## ◆ Preparation

1. Open the water-inlet valve

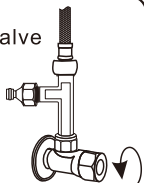

2. Ensure the plug is inserted into socket and the indicator light is on.

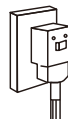

3. Confirm the power icon in LED display is on



4. If the power light on the product indicator panel is not lit, all functions will be unavailable, please press the power button on the operation button panel.



## ◆ How to use

### Sit on the seat

Seating sensor responds to work

Nozzle cleaning indicator lights

If the automatic deodorization function is turned on, the deodorization starts to work



#### Front wash

Press , nozzle reaches out to work; Press again change to front oscillating cleansing, nozzle repeatedly swings back or front. Press again to stop oscillating cleansing, Switch back to front wash.

#### Rear wash

Press , nozzle reaches out to work; Press again change to rear oscillating cleansing, nozzle repeatedly swings back or front. Press again, stop oscillating cleansing. Switch back to rear wash.

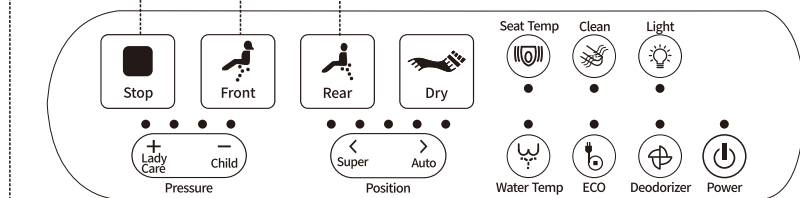

#### Stop

Stop the current cleaning operation. If do not press stop button, rear washing/ front washing will stop automatically after 2minutes.

#### Water pressure adjustment

4-paragraph for choosing, adjust comfortable water pressure by pressing



Indicator display → ● ● ● ●

#### Nozzle position adjustment

5-paragraph for adjusting the satisfied position to clean by pressing



Indicator display → ● ● ● ● ●

Notice: Under oscillating cleaning, the nozzle position adjustment is unavailable

## Nozzle clean

Press  to enter nozzle cleaning, then water flows out and you can clean the nozzle. Press the stop button to end immediately

※Nozzle clean is effective when people are not seated.

※Nozzle will automatically clean the peripheral part of the nozzle before rear wash and front wash.

## Stop

Turn off the drying function. Or the warm air will stop automatically after running for 4 minutes.

## Dryer

Press this button to start warm air drying.

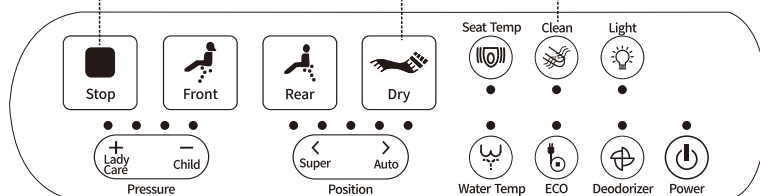

## Warm air temp adjustment

4-paragraph for choosing, adjust warm air temp by pressing

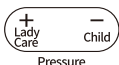

Indicator display → ● ● ● ●

## Water temp

The water temperature can be adjusted in 4 levels, normal room temp, 1st, 2nd and 3rd. Normal room temperature does not heat, water temperature indicator does not light: Press this button once, the water temperature indicator lights up, and displays blue, corresponding to 33 °C; Press this button again, the water temperature indicator displays green, corresponding to 36 °C; Press this button again, the water temperature indicator is red, corresponding to 39 °C . Each time you press this button, the water temperature switches to the next level.

Indicator →   
Water Temp

## Lady care

Press this button to enter lady care in idle mode, nozzle reaches out to work and water temp is set to the highest level (39°C), water pressure is set to 2-level, cleaning position set as default.

Water temp/water pressure unadjustable, cleaning position is adjustable in this mode, automatic ends after cleaning for 2 mins. Press  to end.

## Strong wash

Press this button to enter the powerful washing mode in idle mode, nozzle reaches out to work and the hole starts to effluent. Water pressure is highest level, after washing 2mins to end. Press  to end.

## Reminder

Idle mode means rear wash, front wash, dryer, flush, etc. are not working.

Child wash, one solution, strong wash, lady care must be enabled in idle mode.

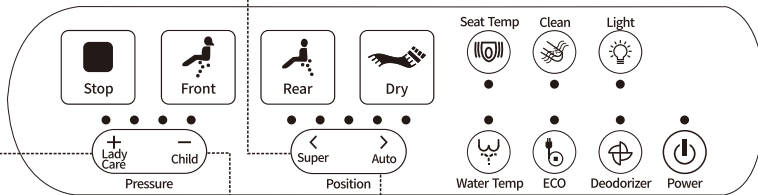

## Child wash

Press this button to enter child wash in idle mode, nozzle reaches out to work and nozzle position is at the front (5 level), mini water pressure (1 level), and the water temp is mid grade (36°C) After washing 30s to end or press  to end.

Under this mode, cleaning position/ water pressure / water temp are unadjustable.

## One solution

Press this button to start in idle mode, the order is rear wash 40s→oscillate wash 20s→ warm air dryer 2 mins → stop. In this mode press  to end.

## Deodorizer

Press this button to start deodorizing, indicator on the control panel lights up. Press again to close.

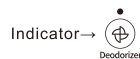

## Reminder

During drying, the deodorizing function is temporarily stopped, and it will automatically start again after the drying is completed. When a person leaves the seat, the deodorizing function will continue to work automatically after 1.5 minutes.



## Night light

Press this button, the indicator lights up, and the night light turns on. Press this button again, the indicator is off, the night light is also off, it could be switched repeatedly.

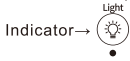

## Power

Press this button, the machine will standby, all the lights are off. When press again, the machine is power on, and the power indicator lights on.

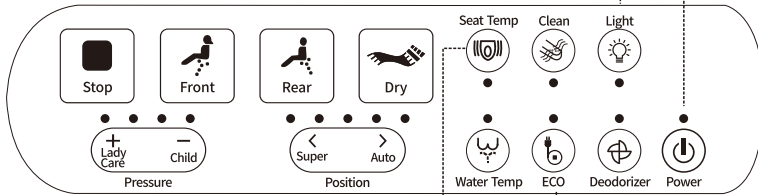
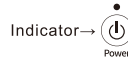

## Seat temp

The seat temperature can be adjusted in 4 levels, normal room temp, 1st, 2nd and 3rd. Normal room temperature does not heat, seat temperature indicator does not light: Press this button once, the seat temperature indicator lights up, and displays blue, corresponding to 33 °C; Press this button again, the seat temperature indicator displays green, corresponding to 36 °C; Press this button again, the seat temperature indicator is red, corresponding to 39 °C. Each time you press this button, the seat temperature switches to the next level.

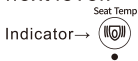

Attention: To prevent the low temp burn, the machine automatically reduces the seat temp below 35 °C after sit on the seat for 10 minutes.

## Power save

Press this button, the corresponding indicator blink on control panel in standby, After leaving the seat for 1.5 minutes then enter power saving mode. Under this mode, seat temp is kept at 25°C, and the settings before power saving are automatically restored the next time.



## Buzzer

Buzz once: Sit on seat condition, all the functions are available.

Buzz twice: Off the seat condition, parts of the functions are available.

Buzz three times or more: There are faults of the product.

Reminder

Buzzer only works when operate on remote controller or side button or initialization.

## UV sterilization \*

When the human body leaves the seat for 15 seconds, the UV sterilization function will automatically works and sterilizes the nozzle for 3 minutes. Every 4 hours, it will start again.

Note: This function will be different due to different model configurations. The low-light light will flashes for 3 seconds when the UV sterilization starts. During the operation, do not look it directly, otherwise it may cause permanent damage to the eyes.

## ◆ Trouble shooting ◆

SITUATION	REASON	PROCESS
No power	The electrical outlet is not connect to power supply or the plug is not insert to the bottom	Check if the electrical outlet is connected to the power supply; press the reset key on the plug
No water comes out while cleaning	Low pressure of water supply	Raise the water pressure
	Water inlet filter blocked	Remount and clean the filter according to the instruction
Cleansing water in not warm enough	Water temp setting is incorrect	Readjust
Seat does not heat	Seat temp setting is incorrect or the product is in power saving mode	Readjust
Seat and cover are loose	Fixed bolts are loose	Tighten the bolts
No response when pressing the key	Key fault	Reboot or contact ascendant

# Cleaning and Maintenance

## ● Toilet bowl cleaning

- ◆ Please make sure the electrical plug is taken out
- ◆ Please use wettish soft cloth to wipe the toilet shelf and seat.  
The dirt should be cleaned as soon as possible, if it's difficult to clean, you can use neutral detergent.

## ● Nozzle Cleaning and Maintenance

- ◆ Press "nozzle clean", nozzle will come out and start auto wash, then you can use brush to clean it.

Attention:  
Do not use steel brush to clean

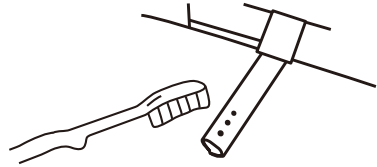

## ● Machine release

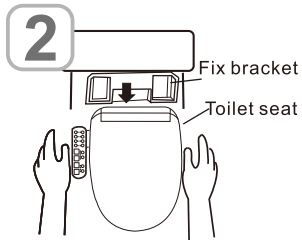

When the whole machine needs to be detached, press the Release button while holding the whole machine and pull it back forcefully.

## ● Cleaning the filter

When the water pressure is too low or insufficient, please clean the filter.

### 1 Close the T valve filter and stop water supply

Notice: Do not remove the filter without closing the T valve filter.  
—Otherwise water will spray out

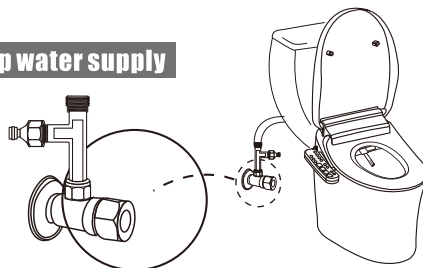

### 2 Remove the T valve filter

unscrew the connector by spanner and then take out the filter.  
For the specific operation, see the figure below:

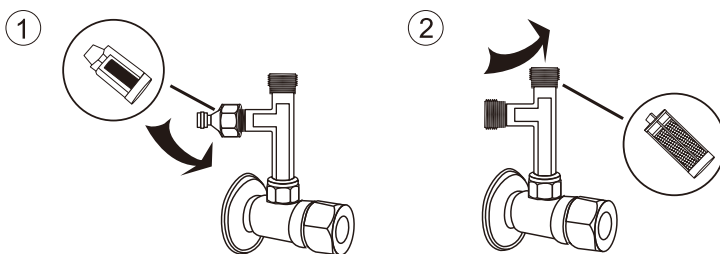

### 3 Clean the filter

Get the filter out and clean it thoroughly.  
----Flush off dirt or clean the filter by toothbrush

Notice: Do not use any cleaning agents.  
Clean it with water only.

Do not use excessive force when cleaning, otherwise the filter will be deformed or damaged, affecting normal use.

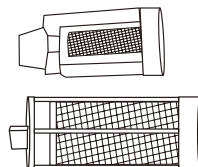

### 4 Reattach the filter

Reinstall filter based on the removal sequence.

Notice: Open the shutoff valve after installation and confirm there's no water leakage.

# Appendix

## ◆ Product specification ◆

Ambient temp range		4°C-40°C	
Inlet water temp range		5°C-35°C	
Rated voltage		<input type="checkbox"/> 220V~ 50Hz	<input type="checkbox"/> 120V~ 60Hz
Rated power		1200W	1200W
(Inlet water temp: 15°C±0.5°C)			
Power cord length		1.5m (0.85m for North America)	
Cleansing device	Water pressure range	0.06MPa-0.75MPa	
	Water pressure adjustment	Adjustable in 4 paragraph	
	Water temp adjustment	4 paragraph adjust: Room temp, 33°C, 36°C, 39°C	
	Safety device	Temp sensor control system、Dry burning-resistant protection device、over temp protection system、water and electricity isolation system	
	Rear wash	0.4-0.6 L/min(water pressure≥0.15MPa)	
	Front wash	0.4-0.65 L/min(water pressure≥0.15MPa)	
	Strong wash	0.45 L/min(water pressure≥0.15MPa)	
Seat heating device	Seat temp control	4 paragraph adjust: Room temp, 33°C, 36°C, 39°C	
	Seat protective system	Temperature sensing control system/ fuse	
Warm air dryer	Warm air temperature	4 paragraph adjustable: 35°C, 42°C, 48°C, 54°C (The wind temp is greatly affected by the environment, and the values are for reference only.)	
	Safety device	Temperature reset switch/fuse	
Deodorizer		Catalyst deodorant box	

## ◆ Packing list ◆

Dear User:

Please check whether the products are complete after you open the box of toilet.  
Product packaging box containing the items are:

- 1 toilet seat
- 1 manual
- 1 rubber gasket
- 1 T valve filter
- 1 PE inlet pipe
- 1 fix bracket
- 1 Filter
- 2 metal gasket
- 2 mounting bolts
- 2 rubber sleeves

## Warning

1. This appliance is not intended for use by persons (including children) with reduced physical, sensory or mental capabilities, or lack of experience and knowledge, unless they have been given supervision or instruction concerning use of the appliance by a person responsible for their safety.
2. Children should be supervised to ensure that they do not play with the appliance.
3. If the supply cord is damaged, it must be replaced by the manufacturer, its service agent or similarly qualified persons in order to avoid a hazard.



330D (英)